

# Conical Connection Catalog 2026

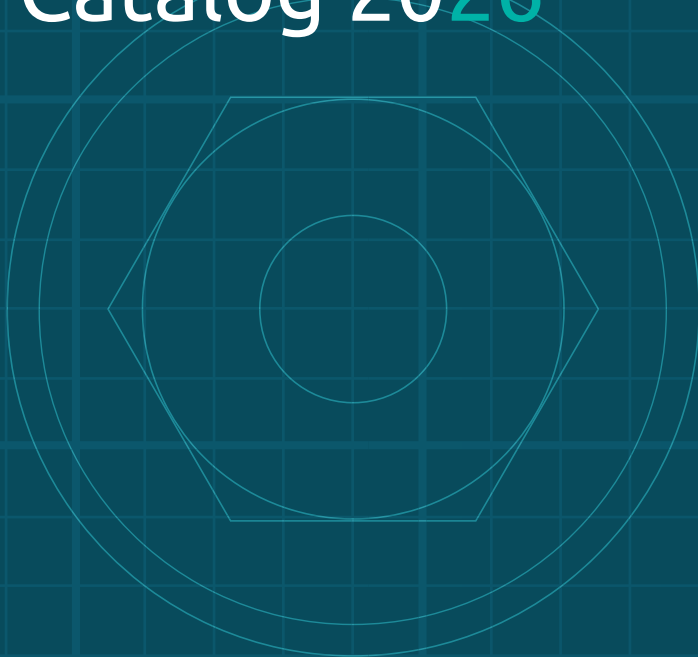

DENTAL IMPLANTS

# CONICAL CONNECTION IMPLANTS

CON Implant NP & RP

28-29

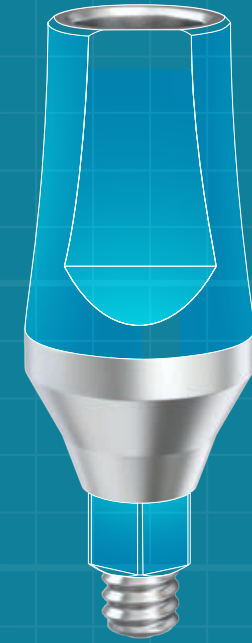

# CON - Spiral Implant

CON RP Implant is based on the popular **Conical Connection** with **SLA - Sand blast, double etched in acid surface treatment**. It has a tapered body with a tight seal interlocking hexagon conical connection that delivers the best aesthetic solution for all indications. Specifically designed to offer high primary stability, making it suitable for challenging situations such as soft bone or extraction sockets. CON RP demonstrates successful implementation across various bone types, providing both ease of insertion and minimal patient sensitivity. It's self-tapping and self-drilling features contribute to a simplified implantation process. CON RP Regular Platform is designed for posterior cases that require a wider base and helps achieve a natural molar emergence profile.

**CONNECTIONS:** Conical Connection NP 2.25mm (Narrow Platform).  
Conical Connection RP 2.65mm (Regular Platform).

**MATERIAL:** Ti-6Al-4V ELI (Titanium Grade 5).

**SURFACE TREATMENT:** SLA - Sandblast, Large Grit, Acid-etch.

**STERILIZATION:** Gamma irradiation.

**SPECIFICATIONS:**

**CONNECTION**

- NP 2.25mm (Narrow Platform), and Conical Connection RP 2.65mm (Regular Platform).



**TAPERED BODY WITH SPIRAL DESIGN**

- The resemblance to natural root shape ensures outstanding primary stability, promotes bone preservation, and facilitates strong adhesion of soft tissues.



**AGGRESSIVE APICAL THREADS**

- The wide spacing between threads enhances implant stability and promotes long-term tissue preservation.



**SLA - SANDBLAST, LARGE GRIT, ACID-ETCH**

- Enhances dental implant stability and osseointegration, improving long-term success rates.

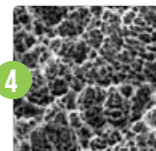

**SELF TAPPING SYSTEM**

- Self-tapping.
- Self-drilling.
- Increases load distribution.



**ROUND APEX**

- Enhances implant stability.
- Protects sinus from perforation, and minimizes the risk of anatomical structure damage.



**PACKAGE CONTENT**

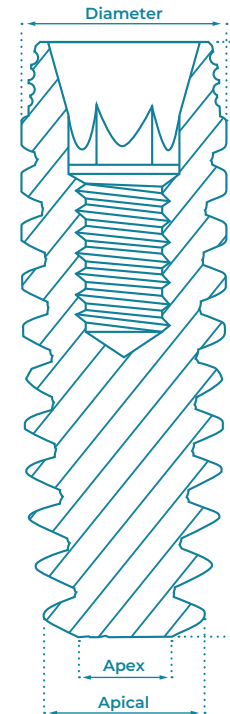
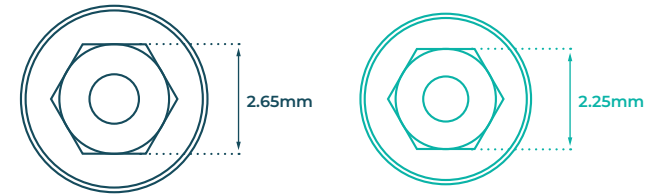
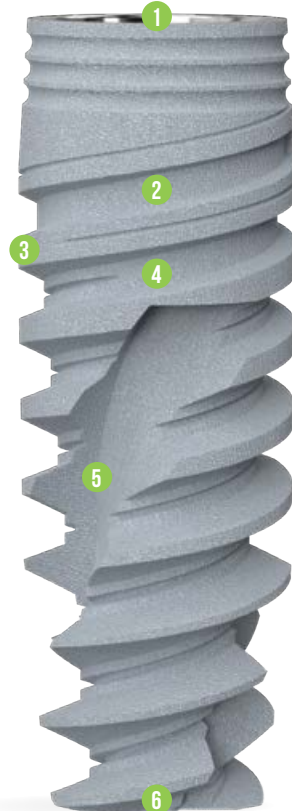
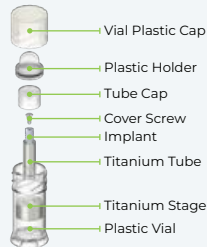

Diameter	L (mm)	Code	Apical	Apex
Ø3.5	8	NP0835	Ø3.45	Ø2.6
	10	RP1035		
	11.5	RP1135		
	13	RP1335		
Ø4.3	16	RP1635	Ø4.1	Ø3.2
	6	RP0643		
	8	RP0843		
	10	RP1043		
Ø5.0	11.5	RP1143	Ø4.65	Ø3.7
	13	RP1343		
	16	RP1643		
	6	RP0650		
	8	RP0850		
	10	RP1050		
Ø5.0	11.5	RP1150	Ø4.65	Ø3.7
	13	RP1350		
	16	RP1650		

Drilling Protocol		Marking Drill	Ø2.0	Ø2.5	Ø2.8	Ø3.2	Ø3.65	Countersink Ø3.75x4.2	Ø4.2	Ø4.5
Ø3.5	Soft Bone	●	○	○	○	○	○	○	○	○
Ø3.5	Hard Bone	●	○	●	●	●	●	●	●	○
Ø4.3	Soft Bone	●	○	○	○	○	○	○	○	○
Ø4.3	Hard Bone	●	○	●	●	●	●	●	●	○
Ø5.0	Soft Bone	●	○	○	○	○	○	○	○	○
Ø5.0	Hard Bone	●	○	●	●	●	●	●	●	○

• The suggested drilling protocol is only a recommendation and should not replace the doctor's opinion.

# CONICAL CONNECTION PROSTHETICS

Cement-Retained Restoration

Screw-Retained Restoration

Overdenture Restoration

75-87

88-91

92-97

CONICAL CONNECTION PROSTHETICS

## CEMENT-RETAINED RESTORATION

Healing Caps

76

Screws

76

Impression Coping Transfers

77-78

Analogs

78

Straight Abutments

79

Angulated Abutments

80-81

Temporary Abutments

82-83

Zirconia Abutments

84

Casting Abutments

85

CAD/CAM Abutments

86-87

NP 2.25mm

RP 2.65mm



Scan the QR Code to visit GDT Implants website

## HEALING CAPS

Their primary purpose is to facilitate the healing process of both soft and hard tissues surrounding the implant. The Healing Caps not only protect the implant from the accumulation of plaque and debris, but also aid in shaping the gumline for optimal aesthetics.

**TORQUE TIGHTENING:** 15 Ncm (Recommendation).

**MATERIAL:** Ti-6Al-4V ELI (Titanium Grade 5).

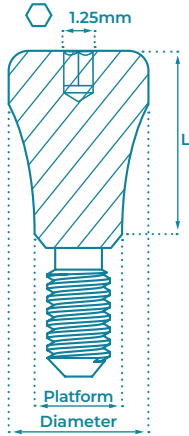

NP HEALING CAPS					Platform - Ø2.25mm
					Diameter - Ø3.8mm
L	2mm	3mm	4mm	5mm	
NP					
CODE	HCSNP2	HCSNP3	HCSNP4	HCSNP5	
RP HEALING CAPS					Platform - Ø2.65mm
					Diameter - Ø4.5mm
L	2mm	3mm	4mm	5mm	
RP					
CODE	HCSR2	HCSR3	HCSR4	HCSR5	

## SCREWS

**MATERIAL:** Ti-6Al-4V ELI (Titanium Grade 5).

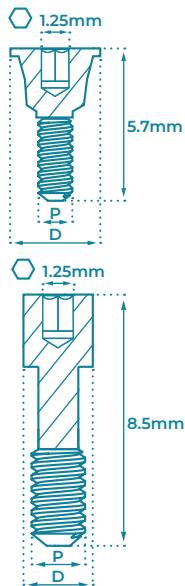

NP COVER SCREW		RP COVER SCREW	
P	Ø2.25mm	Ø2.65mm	
D	Ø3.4mm	Ø4.0mm	
NP		RP	
CODE	CSNP	CSRP	
NP ABUTMENT SCREW		RP ABUTMENT SCREW	
P	Ø1.5mm	Ø1.9mm	
D	Ø2.1mm	Ø2.4mm	
NP		RP	
CODE	SWNP	SWRP	

## IMPRESSION COPING TRANSFERS

Provides unrivaled accuracy during impression-taking to ensure the best possible results with every use. Can be safely sterilized in an autoclave for added security. Ideal for single tooth restorations, bridges, partial dentures, and full dentures alike.

**MATERIAL:** Stainless Steel.

**PACKAGED WITH:** Screw for Closed Tray / Open Tray.

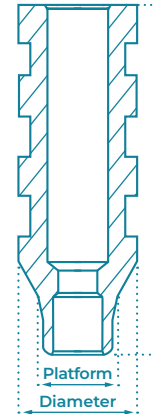

NP TRANSFERS			Platform - Ø2.25mm
			Diameter - Ø4.7mm
TYPE	Closed Tray	Open Tray	
L	9mm	13mm	
NP			
CODE	STRCNP	STRONP	
RP TRANSFERS			Platform - Ø2.65mm
			Diameter - Ø4.7mm
TYPE	Closed Tray	Open Tray	
L	9mm	13mm	
RP			
CODE	STRCRP	STRORP	

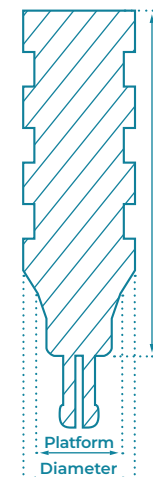

NP CLIP TRANSFERS			Platform - Ø2.25mm
			Diameter - Ø4.7mm
L	9mm	15mm	
NP			
CODE	CTR9NP	CTR15NP	
RP CLIP TRANSFERS			Platform - Ø2.65mm
			Diameter - Ø4.7mm
L	9mm	15mm	
RP			
CODE	CTR9RP	CTR15RP	

Snap-cap Abutment enables quick and simple impression taking. The cap remains in the impression tray after it is removed from the mouth.

**MATERIAL:** Ti-6Al-4V ELI (Titanium Grade 5).

**SNAP-CAP MATERIAL:** Acetal Polymer.

**PACKAGED WITH:** Abutment Fixation Screw **SANP / SARP**, and Snap-Cap **PSOC**

NP SNAP-ON TRANSFERS			Platform - Ø2.25mm Diameter - Ø2.65mm
L	1.5mm	3mm	4.5mm
CODE	SOC15NP	SOC30NP	SOC45NP
RP SNAP-ON TRANSFERS			Platform - Ø2.65mm Diameter - Ø2.65mm
L	1.5mm	3mm	4.5mm
CODE	SOC15RP	SOC30RP	SOC45RP

OVERDENTURE	MULTI UNIT 1.4	MULTI UNIT 1.6	SNAP-ON CAP
TYPE GdtLoc / Ball	Click	Closed tray	Open Tray
CODE	TFB	TFL	NM-TCT
		MU-TCT	MU-TOT
			PSOC

## ANALOGS

The analog provides a replica that shows the exact position of a patient's implant.

**MATERIAL:** Stainless Steel.

NP ANALOG		RP ANALOG	
D	Ø3.5mm	D	Ø3.9mm
L	12mm	L	10mm
CODE	ANGNP	CODE	ANGRP

## STRAIGHT ABUTMENTS

Straight Abutments create a tight seal and strong connection to the implant. Stable and reduce trauma during restoration placement. The Shoulder / Anatomic / Concave Straight Abutments are specifically designed for aesthetics, and promote faster healing while protecting the implant.

**MATERIAL:** Ti-6Al-4V ELI (Titanium Grade 5).

**PACKAGED WITH:** Abutment Fixation Screw **SANP / SARP**.

**TORQUE TIGHTENING:** 25 Ncm (Recommendation).

NP 0°		Platform - Ø2.25mm Diameter - Ø3.6mm
L	9mm	13mm
CODE	SANP9	SANP13
RP 0°		Platform - Ø2.65mm Diameter - Ø4mm
L	9mm	13mm
CODE	SARP9	SARP13

NP WITH SHOULDER			Platform - Ø2.25mm Diameter - Ø4mm
L	1mm	2mm	3mm
CODE	SASNP1	SASNP2	SASNP3
RP WITH SHOULDER			Platform - Ø2.65mm Diameter - Ø4mm
L	1mm	2mm	3mm
CODE	SASRP1	SASRP2	SASRP3

## ANGULATED ABUTMENTS

Can be used in a single tooth, and partially or totally edentulous situations. Used in the fabrication of cement-retained restorations, single crowns, or bridges, and can be used in unparallel implant placement cases for angle compensation.

**MATERIAL:** Ti-6AL-4V ELI (Titanium Grade 5).

**PACKAGED WITH:** Abutment Fixation Screw **SANP / SARP**.

**TORQUE TIGHTENING:** 25 Ncm (Recommendation).

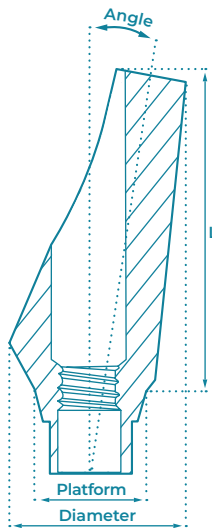

NP 15°		Platform - Ø2.25mm Diameter - Ø3.85mm
L	9mm	



CODE	ATA15NP
------	---------

RP 15°		Platform - Ø2.65mm Diameter - Ø3.85mm
L	9mm	



CODE	ATA15RP
------	---------

NP 25°		Platform - Ø2.25mm Diameter - Ø3.85mm
L	9mm	



CODE	ATA25NP
------	---------

RP 25°		Platform - Ø2.65mm Diameter - Ø3.85mm
L	9mm	



CODE	ATA25RP
------	---------

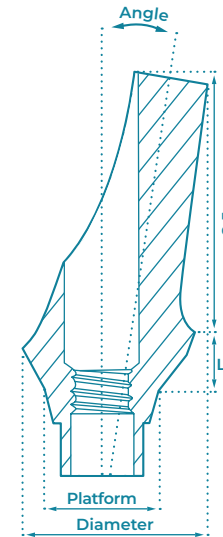

NP ANATOMIC 15°			Platform - Ø2.25mm Diameter - Ø5mm
L	1.5mm	3mm	4.5mm



CODE	ATA1515NP	ATA1530NP	ATA1545NP
------	-----------	-----------	-----------

RP ANATOMIC 15°			Platform - Ø2.65mm Diameter - Ø5mm
L	1.5mm	3mm	4.5mm



CODE	ATA1515RP	ATA1530RP	ATA1545RP
------	-----------	-----------	-----------

NP ANATOMIC 25°			Platform - Ø2.25mm Diameter - Ø5mm
L	1.5mm	3mm	4.5mm



CODE	ATA2515NP	ATA2530NP	ATA2545NP
------	-----------	-----------	-----------

RP ANATOMIC 25°			Platform - Ø2.65mm Diameter - Ø5mm
L	1.5mm	3mm	4.5mm



CODE	ATA2515RP	ATA2530RP	ATA2545RP
------	-----------	-----------	-----------

## TEMPORARY ABUTMENTS

### Titanium Abutments

Easily adapts to a gingival tissue and makes a perfect solid marginal seal between the abutment and the implant.

**MATERIAL:** Ti-6Al-4V ELI (Titanium Grade 5).

**PACKAGED WITH:** Abutment Fixation Screw **SANP / SARP**.

**TORQUE TIGHTENING:** 20 Ncm (Recommendation).

	NP ROTATIONAL	RP ROTATIONAL
<b>P</b>	Ø2.25mm	Ø2.65mm
<b>CODE</b>	STANNP	STANRP
	NP ANTI ROTATIONAL	RP ANTI ROTATIONAL
<b>P</b>	Ø2.25mm	Ø2.65mm
<b>CODE</b>	STARNP	STARRP

Technical drawing of a titanium abutment showing dimensions: Ø3.7, 13mm, 3mm, Platform, Ø4.5.

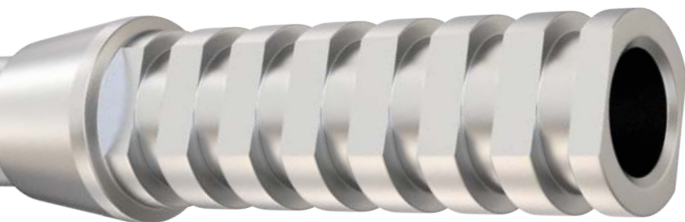

22  
**Ti**  
Titanium  
47.867

### PEEK Abutments

PEEK is described as an excellent combination of strength and elasticity. It is one of the most chemically resistant materials, biocompatible and aesthetic, with low electrical conductivity. The PEEK Abutments are used for short term rehabilitation.

**MATERIAL:** PEEK (Polyether ether ketone).

**TORQUE TIGHTENING:** 15 Ncm (Recommendation).

**PACKAGED WITH:** Abutment Fixation Screw **SANP / SARP**.

	NP ANATOMIC 0°		
	Platform - Ø2.25mm Diameter - Ø4.75mm		
<b>L</b>	1.5mm	3mm	4.5mm
<b>CODE</b>	PAT15NP	PAT30NP	PAT45NP
	RP ANATOMIC 0°		
	Platform - Ø2.65mm Diameter - Ø4.75mm		
<b>L</b>	1.5mm	3mm	4.5mm
<b>CODE</b>	PAT15RP	PAT30RP	PAT45RP

Technical drawing of a PEEK abutment showing dimensions: 8mm, L, Platform, Diameter.

	NP ANATOMIC 15°		
	Platform - Ø2.25mm Diameter - Ø?mm		
<b>L</b>	1.5mm	3mm	4.5mm
<b>CODE</b>	PAT1515NP	PAT1530NP	PAT1545NP
	RP ANATOMIC 15°		
	Platform - Ø2.65mm Diameter - Ø?mm		
<b>L</b>	1.5mm	3mm	4.5mm
<b>CODE</b>	PAT1515RP	PAT1530RP	PAT1545RP

Technical drawing of a PEEK abutment showing dimensions: Angle, 8.5mm, L, Platform, Diameter.

## ZIRCONIA ABUTMENTS WITH TITANIUM BASE





Zirconia exhibits exceptional resistance to high temperatures and corrosion caused by alkalis, acids, saltwater, and various other substances. Lighter than metal, zirconia possesses remarkable strength, malleability, and ductility. It's chemical and physical characteristics bear resemblance to those of titanium. Highly aesthetic and especially good for anterior restorations.

**ABUTMENT MATERIAL:** Zirconia (ZrO<sub>2</sub>) with Ti-6Al-4V ELI (Titanium Grade 5) Base.

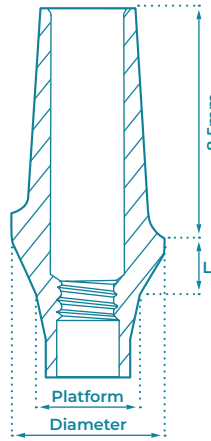



**PACKAGED WITH:** Fixation Screw for Zirconia Abutments **ZSANP / ZSARP**.

**TORQUE TIGHTENING:** 30 Ncm (Recommendation).

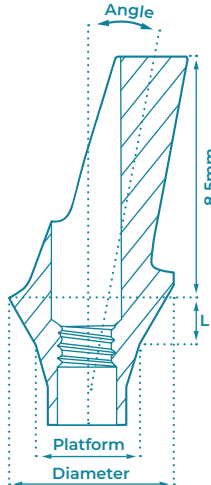

NP ANATOMIC 0°		Platform - Ø2.25mm Diameter - Ø5.5mm
L	1.5mm	
		
CODE	ZAT15NP	
RP ANATOMIC 0°		Platform - Ø2.65mm Diameter - Ø6.0mm
L	1.5mm	
		
CODE	ZAT15RP	



NP ANATOMIC 15°		Platform - Ø2.25mm Diameter - Ø5.5mm
L	1.5mm	
		
CODE	ZAT151NP	
RP ANATOMIC 15°		Platform - Ø2.65mm Diameter - Ø6.0mm
L	1.5mm	
		
CODE	ZAT151RP	

## CASTING ABUTMENTS





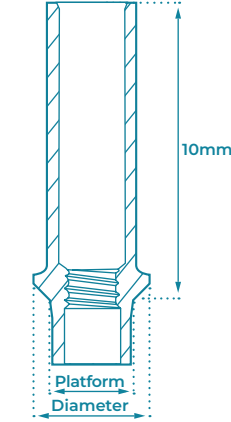

Used by dental technicians for constructing prosthetic restoration. Provide excellent grip and optimal connection to the implant. Made for a very strong plastic material that retains its shape.

**MATERIAL:** Polyoxymethylene (POM).

**PACKAGED WITH:** Abutment Fixation Screw **SANP / SARP**.





**TORQUE TIGHTENING:** 15 Ncm (Recommendation).

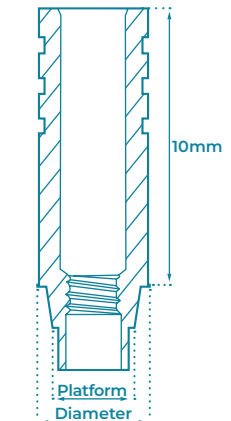

NP PLASTIC ABUTMENT		Platform - Ø2.25mm Diameter - Ø3.6mm
TYPE	Anti-rotational	Rotational
		
CODE	PCWNP	PCNNP
RP PLASTIC ABUTMENT		Platform - Ø2.65mm Diameter - Ø4mm
TYPE	Anti-rotational	Rotational
		
CODE	PCWRP	PCNRP

**CHROME BASE TORQUE TIGHTENING:** 30 Ncm (Recommendation).

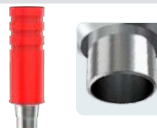

NP CHROME COBALT BASE		Platform - Ø2.25mm Diameter - Ø4.5mm
TYPE	Anti-rotational	Rotational
		
CODE	CCBWNP	CCBNNP
RP CHROME COBALT BASE		Platform - Ø2.65mm Diameter - Ø4.5mm
TYPE	Anti-rotational	Rotational
		
CODE	CCBWRP	CCBNRP

# CAD/CAM ABUTMENTS

GDT 3D CAD/CAM libraries make it easy to design and create your implant platforms. Fully supported by the top CAD/CAM systems: **Exocad and 3Shape**.

Our libraries enable precise computerized planning by scanning implants and abutments of all types, the scanned information used for creating restorations.

The CAD/CAM technology simplifies the process, ensuring accuracy and speed.

**MATERIAL:** Ti-6Al-4V ELI (Titanium Grade 5).

**PACKAGED WITH:** Abutment Fixation Screw **SANP / SARP**.

**TORQUE TIGHTENING:** 25 Ncm (Recommendation).



Scan **QR code** or refer to GDT Dental Implants Youtube channel to watch video: <https://www.youtube.com/watch?v=pjUwx6vdGfE>



Scan **QR code** or refer to GDT Dental Implants website to download our libraries: [www.gdentalt.com/cadcam](http://www.gdentalt.com/cadcam) **exocad 3shape**

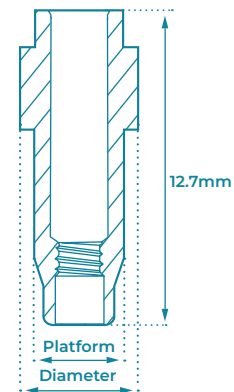
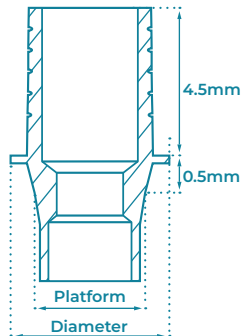

NP TITANIUM BASE		Platform - Ø2.25mm
		Diameter - Ø3.6mm
<b>TYPE</b>	Anti-rotational	Rotational
<b>NP</b>		
<b>CODE</b>	TBSNP	TBSNRP
RP TITANIUM BASE		Platform - Ø2.65mm
		Diameter - Ø4mm
<b>TYPE</b>	Anti-rotational	Rotational
<b>RP</b>		
<b>CODE</b>	TBSRP	TBSNRP
NP SCAN BODY		RP SCAN BODY
<b>P</b>	Ø2.25mm	Ø2.65mm
<b>D</b>	Ø3.0mm	Ø3.5mm
<b>NP</b>		
<b>CODE</b>	SBANP	SBARP

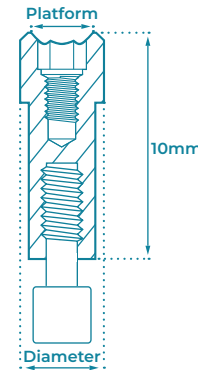

**MATERIAL:** Stainless Steel.

NP 3D ANALOG		RP 3D ANALOG
<b>P</b>	Ø2.25mm	Ø2.65mm
<b>D</b>	Ø3.5mm	Ø3.9mm
<b>NP</b>		
<b>CODE</b>	ANG3DNP	ANG3DRP

## FOR MULTI UNIT ABUTMENTS 1.6mm

**TORQUE TIGHTENING:** MU-SA Screw - 15 Ncm (Recommendation).

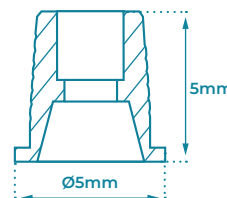
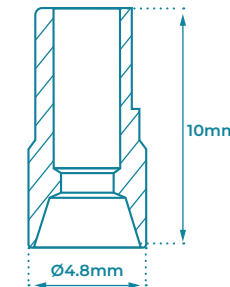
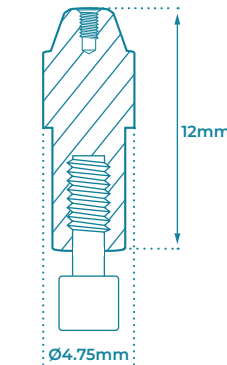

3D PRINTING ANALG		Diameter - Ø4.75mm
<b>L</b>	12mm	
<b>FITS ALL PLATFORMS</b>		Stainless Steel
<b>CODE</b>	MU-ANG3D	
PEEK SCAN BODY		Diameter - Ø4.8mm
<b>L</b>	10mm	
<b>FITS ALL PLATFORMS</b>		
<b>CODE</b>	MU-SBA	
TITANIUM BASE		Diameter - Ø5mm
<b>L</b>	5mm	
<b>FITS ALL PLATFORMS</b>		MU-SA Screw is included
<b>CODE</b>	MU-TBS	

CONICAL CONNECTION PROSTHETICS

# SCREW-RETAINED RESTORATION

Multi Unit 1.6mm Abutments

92-93

TITANIUM GRADE 5 (TI-6AL-4V ELI)

STRAIGHT AND ANGULATED

NP 2.25mm | RP 2.26mm

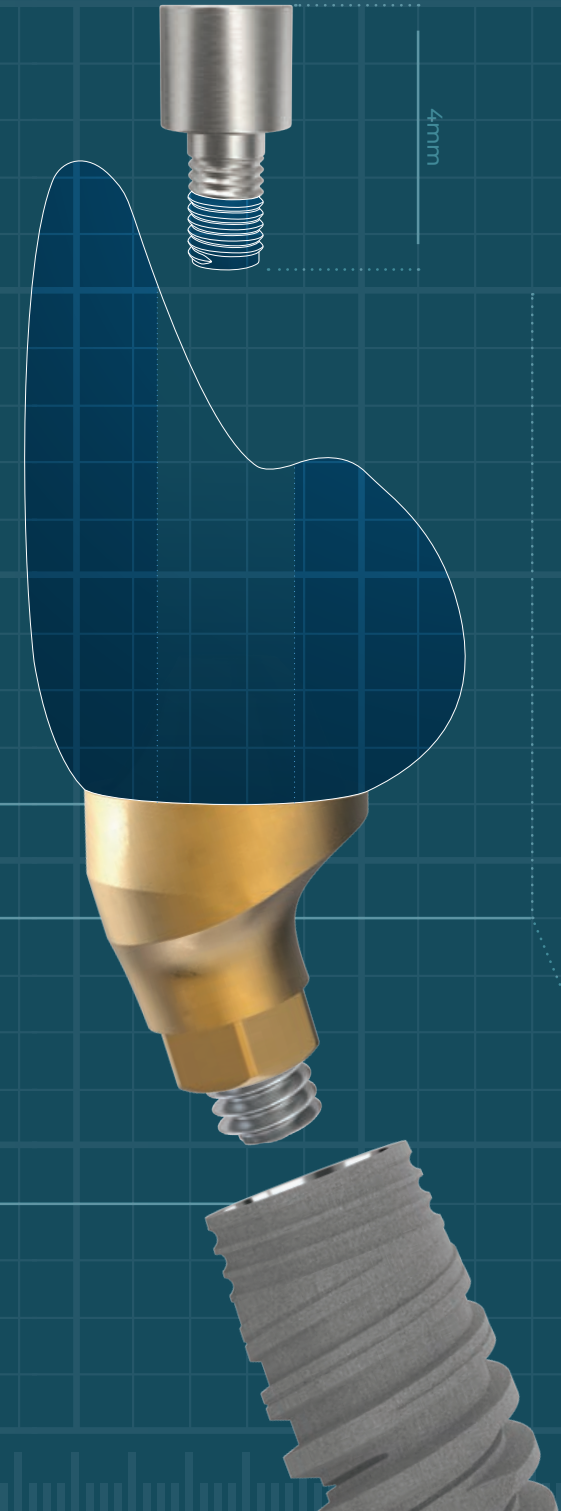

# MULTI UNIT ABUTMENTS 1.6mm

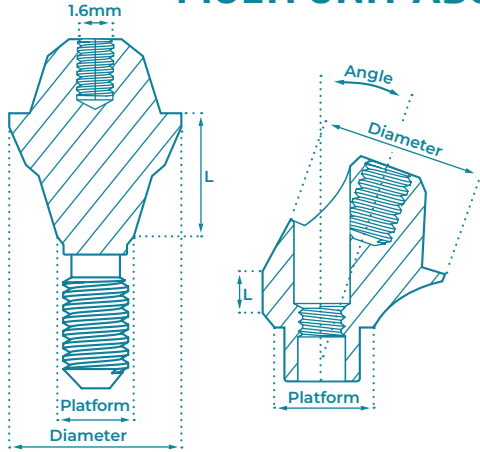

Our range of Multi Unit abutments provides a selection of gingival heights, and fits various implant angulation positions.

Suitable for both Narrow and Regular Conical Connection platforms, ensuring compatibility with different implant systems.

- 1.6mm Prosthetic connection.

**MATERIAL:**  
Ti-6Al-4V ELI (Titanium Grade 5).

**PACKAGED WITH:**  
Abutment Fixation Screw **SANP / SARP**, and Abutment Handle (*\*Only with Angulated Abutments*)

**TORQUE TIGHTENING:**  
35 Ncm for Abutments (Recommendation).  
20 Ncm for Prosthetic Parts (Recommendation).

## COMPONENTS



TITANIUM SLEEVE			PLASTIC SLEEVE			OPEN TRANSFER					
D	Ø4.8mm	L	12mm	D	Ø4.8mm	L	12mm	D	Ø5mm	L	15mm
MU-TSL			MU-PSL			MU-TOT					
MU-SA Screw is included			MU-SA Screw is included								
CLOSED TRANSFER			ANALOG			HEALING CAP					
D	Ø4.8mm	L	7.2mm	D	Ø4.8mm	L	13.5mm	D	Ø4.8mm	L	5.2mm
MU-TCT			MU-ANG			MU-HC					
MU-SA Screw is included						MU-SA Screw is included					
TITANIUM BASE			3D PRINTING ANALOG			SCAN BODY					
D	Ø5mm	L	4.8mm	D	Ø4.8mm	L	12mm	D	Ø4.8mm	L	10mm
MU-TBS			MU-ANG3D			MU-SBA					
MU-SA Screw is included						MU-SA Screw is included					
ABUTMENT HANDLE			FIXATION SCREW								
Premounted on angulated abutments			MU-SA								

NP 0°					Platform - Ø2.25mm
					Diameter - Ø4.8mm
L	1mm	2mm	3mm	4mm	5mm
CODE	MU1NP	MU2NP	MU3NP	MU4NP	MU5NP
RP 0°					Platform - Ø2.65mm
					Diameter - Ø4.8mm
L	1mm	2mm	3mm	4mm	5mm
CODE	MU1RP	MU2RP	MU3RP	MU4RP	MU5RP
NP 17°		Platform - Ø2.25mm	RP 17°		Platform - Ø2.65mm
		Diameter - Ø4.8mm			Diameter - Ø4.8mm
L	1mm	2mm	1mm	2mm	
CODE	MU-17-1NP	MU-17-2NP	MU-17-1RP	MU-17-2RP	
NP 30°		Platform - Ø2.25mm	RP 30°		Platform - Ø2.65mm
		Diameter - Ø4.8mm			Diameter - Ø4.8mm
L	1mm	2mm	1mm	2mm	
CODE	MU-30-1NP	MU-30-2NP	MU-30-1RP	MU-30-2RP	

CONICAL CONNECTION PROSTHETICS

# OVERDENTURE RESTORATION

Ball Attachment

Click Attachment

96-97

98-99

METAL HOUSING

SILICONE CAP

ANGULATED AND STRAIGHT

TITANIUM GRADE 5 (TI-6AL-4V ELI)

NP 2.25mm | RP 2.26mm

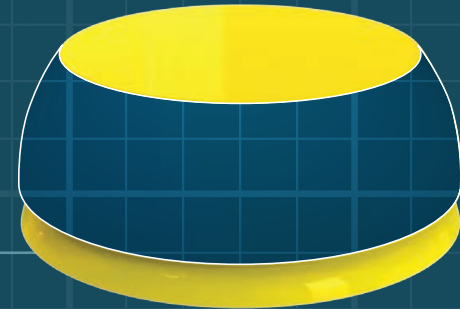
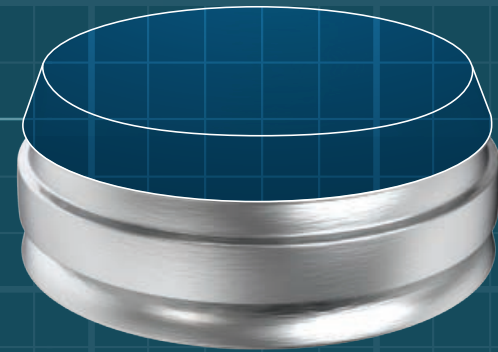

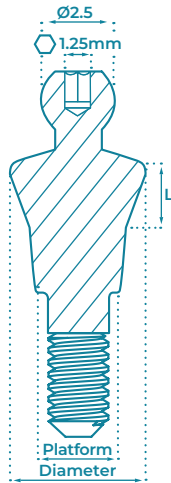

## BALL ATTACHMENT

Designed to provide a secure and stable connection between a denture and a dental implant.

Suitable for both Narrow and Regular Conical Connection platforms, ensuring compatibility with different implant systems.

**MATERIAL:**

Ti-6Al-4V ELI (Titanium Grade 5).















**TORQUE TIGHTENING:**

25 Ncm (Recommendation).

### BALL ATTACHMENT PARTS



EXTRA SOFT SILICONE CAP		SOFT SILICONE CAP		STANDARD SILICONE CAP	
Retention	0.5 kg / 1.1 lbs	Retention	0.9 kg / 2 lbs	Retention	1.3 kg / 2.9 lbs
	YELLOW		PINK		CLEAR
SYCB		SPCB		SWCB	
LABORATORY USE SILICONE CAP		PROTECTIVE DISC		METAL HOUSING	
Retention	0 kg / lbs				
	BLACK		CLEAR		
SBCB		DPB		MTCB	
ANALOG			IMPRESSION COPING TRANSFER		
					
AFB		TFB			
INSERTION AND EXTRACTION DRIVER					HCP

NP BALL ATTACHMENT						Platform - Ø2.25mm
						Diameter - Ø3.5mm
L	1mm	2mm	3mm	4mm	5mm	6mm
						
CODE	BAT-NP-1	BAT-NP-2	BAT-NP-3	BAT-NP-4	BAT-NP-5	BAT-NP-6
RP BALL ATTACHMENT						Platform - Ø2.65mm
						Diameter - Ø5.0mm
L	1mm	2mm	3mm	4mm	5mm	6mm
						
CODE	BAT-RP-1	BAT-RP-2	BAT-RP-3	BAT-RP-4	BAT-RP-5	BAT-RP-6

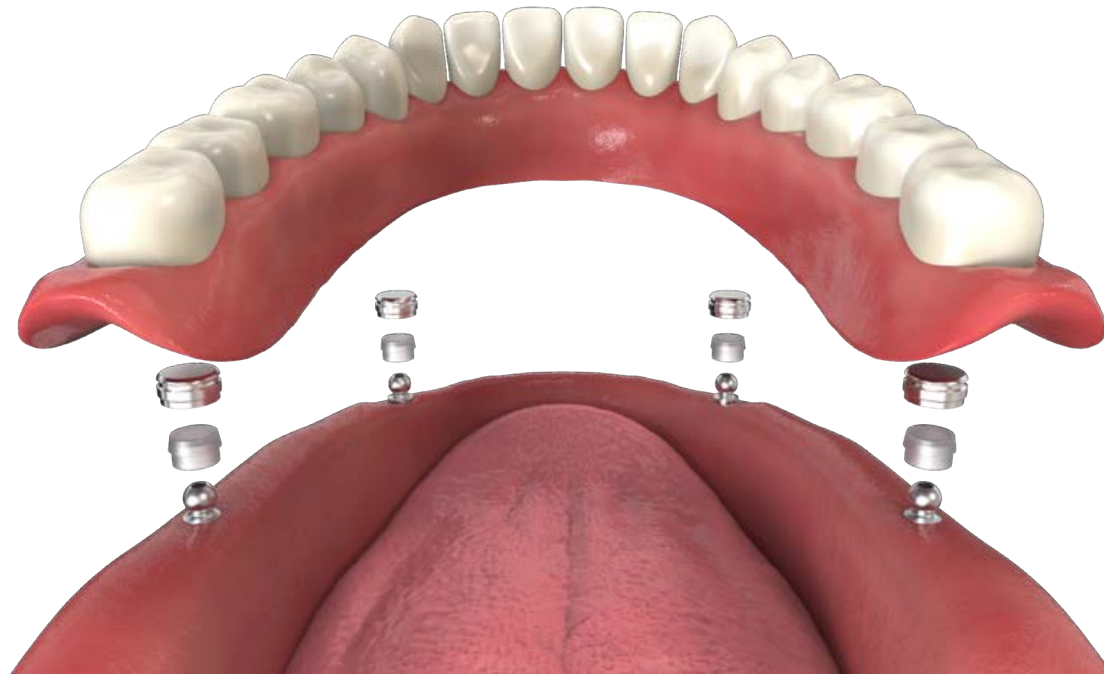

# CLICK ATTACHMENT

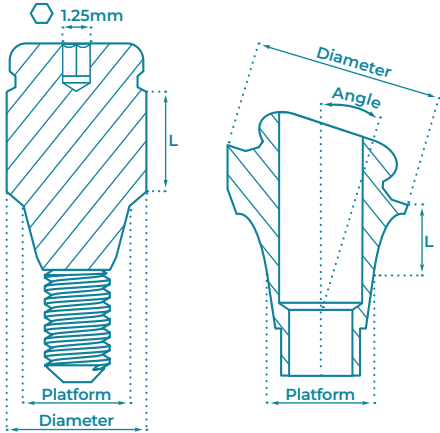

Removable denture attachments system that provides a secure and stable connection between a denture and a dental implant.

Suitable for both Narrow and Regular Conical Connection platforms, ensuring compatibility with different implant systems.











**MATERIAL:**  
Ti-6Al-4V ELI (Titanium Grade 5).

**PACKAGED WITH:**  
Abutment Fixation Screw SA.  
(\*Only with Angulated abutments).

**TORQUE TIGHTENING:**  
25 Ncm (Recommendation).

## CLICK ATTACHMENT PARTS



<b>EXTRA SOFT SILICONE CAP</b>	<b>SOFT SILICONE CAP</b>	<b>STANDARD SILICONE CAP</b>
Retention 0.6 kg / 1.3 lbs	Retention 1.2 kg / 2.6 lbs	Retention 1.8 kg / 4.0 lbs
 <b>YELLOW</b>	 <b>PINK</b>	 <b>CLEAR</b>
SYCL	SPCL	SWCL
<b>STRONG SILICONE CAP</b>	<b>LABORATORY USE SILICONE CAP</b>	<b>PROTECTIVE DISC</b>
Retention 2.5 kg / 5.5 lbs	Retention 0 kg / lbs	
 <b>PURPLE</b>	 <b>BLACK</b>	 <b>PINK</b>
STCL	SBCL	DP
<b>METAL HOUSING</b>	<b>ANALOG</b>	<b>IMPRESSION COPING TRANSFER</b>
		
MTCL	AFL	TFL
<b>INSERTION AND EXTRACTION DRIVER</b>		
		HLC

NP 0°					Platform - Ø2.65mm
					Diameter - Ø4.1mm
<b>L</b>	1mm	2mm	3mm	4mm	5mm
					
<b>CODE</b>	LOC-NP-1	LOC-NP-2	LOC-NP-3	LOC-NP-4	LOC-NP-5

RP 0°					Platform - Ø2.65mm
					Diameter - Ø4.1mm
<b>L</b>	1mm	2mm	3mm	4mm	5mm
					
<b>CODE</b>	LOC-RP-1	LOC-RP-2	LOC-RP-3	LOC-RP-4	LOC-RP-5

NP 18°			Platform - Ø2.65mm	RP 18°			Platform - Ø2.65mm
			Diameter - Ø5.2mm				Diameter - Ø5.2mm
<b>L</b>	1mm	2mm	3mm	1mm	2mm	3mm	
							
<b>CODE</b>	LOC-NP-1810	LOC-NP-1820	LOC-NP-1830	LOC-RP-1810	LOC-RP-1820	LOC-RP-1830	

NP 30°			Platform - Ø2.65mm	RP 30°			Platform - Ø2.65mm
			Diameter - Ø5.2mm				Diameter - Ø5.2mm
<b>L</b>	1mm	2mm	3mm	1mm	2mm	3mm	
							
<b>CODE</b>	LOC-NP-3010	LOC-NP-3020	LOC-NP-3030	LOC-RP-3010	LOC-RP-3020	LOC-RP-3030	

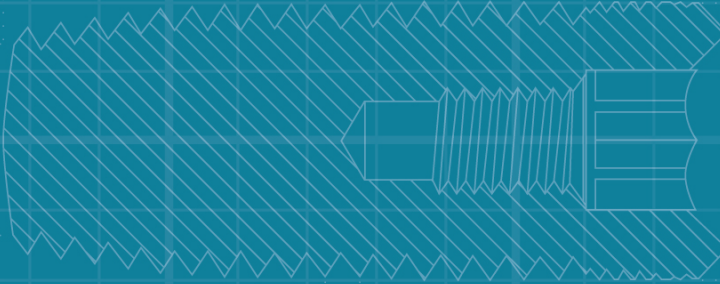

# ALL SOLUTION FOR A PERFECT SMILE



[www.gdentalt.com](http://www.gdentalt.com)

## Global Dental Transfers Ltd.

M Tower Building  
Recha Freier 9  
Beer Sheva  
8489440  
Israel

Tel: +1(201) 759-9990  
Email: [Info@gdentalt.com](mailto:Info@gdentalt.com)